

1. Description

BLP023N10, the N-channel Enhanced Power MOSFETs, is obtained by advanced double trench technology which reduce the conduction loss, improve switching performance and enhance the avalanche energy. This is suitable device for BMS and high current switching applications.

KEY CHARACTERISTICS

Parameter	Value	Unit
V _{DSS}	100	V
I _D	326	A
R _{DS(on).typ}	1.4	mΩ

FEATURES

- Fast Switching
- Low On-Resistance
- Low Gate Charge
- Low Reverse transfer capacitances
- High avalanche ruggedness
- RoHS product

APPLICATIONS

- BMS
- High current switching applications

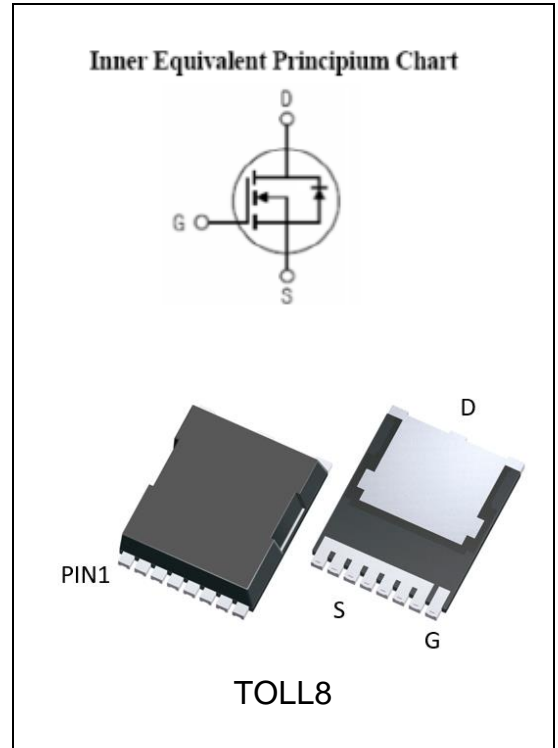

ORDERING INFORMATION

Ordering Codes	Package	Product Code	Packing
BLP023N10-T	TOLL8	P023N10	Reel

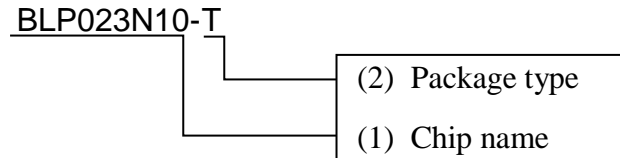
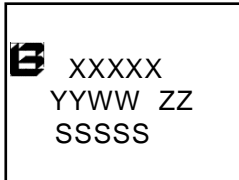
<p>BLP023N10-T</p>  <p>(1) BLP023N10: 2.3mΩ/100V (2) T: TOLL8</p>	 <p>XXXXX: Product Code YYWW: Year&Week ZZ: Assembly Code SSSSS: Lot Code</p>
--	---

2. ABSOLUTE RATINGS

at $T_C=25^\circ\text{C}$, unless otherwise specified

Symbol	Parameter	Rating	Units
V_{DSS}	Drain-Source Voltage	100	V
I_D	Continuous Drain Current, Silicon Limited	326	A
	Continuous Drain Current, Package Limited	360	A
	Continuous Drain Current @ $T_C=100^\circ\text{C}$, Silicon Limited	206	A
I_{DM} ^{Note1}	Pulsed Drain Current	1304	A
V_{GS}	Gate-Source Voltage	± 20	V
E_{AS} ^{Note2}	Avalanche Energy	1225	mJ
P_D	Power Dissipation	416.6	W
	Derating Factor above 25°C	3.33	W/ $^\circ\text{C}$
T_J, T_{stg}	Operating Junction and Storage Temperature Range	150, -55 to 150	$^\circ\text{C}$
T_L	Maximum Temperature for Soldering	260	$^\circ\text{C}$

Note1: Repetitive Rating: Pulse width limited by maximum junction temperature

Note2: $L=0.5\text{mH}$, $I_{as}=70\text{A}$, Start $T_J=25^\circ\text{C}$

3. Thermal characteristics

Symbol	Parameter	Max	Units
$R_{\theta JC}$	thermal resistance, Junction-Case	0.3	$^\circ\text{C}/\text{W}$
$R_{\theta JA}$	thermal resistance, Junction-Ambient	62.5	$^\circ\text{C}/\text{W}$

4. Electrical Characteristics

at $T_C=25^\circ\text{C}$, unless otherwise specified

OFF Characteristics						
Symbol	Parameter	Test Conditions	Values			Units
			Min	Typ	Max	
V_{DSS}	Drain-Source Breakdown Voltage	$V_{GS}=0\text{V}$, $I_D=250\mu\text{A}$	100	110	--	V
I_{DSS}	Drain-Source Leakage Current	$V_{DS}=100\text{V}$, $V_{GS}=0\text{V}$	--	--	1	μA
		$V_{DS}=80\text{V}$, $V_{GS}=0\text{V}$ @ $T_C=125^\circ\text{C}$	--	--	100	μA
$I_{GSS(F)}$	Gate-Source Forward Leakage	$V_{GS}=+20\text{V}$	--	--	100	nA
$I_{GSS(R)}$	Gate-Source Reverse Leakage	$V_{GS}=-20\text{V}$	--	--	-100	nA

ON Characteristics

Symbol	Parameter	Test Conditions	Values			Unit S
			Min	Typ	Max	
$R_{DS(on)}$	Drain-Source On-Resistance	$V_{GS}=10V, I_D=50A$	--	1.4	1.8	m Ω
$V_{GS(th)}$	Gate Threshold Voltage	$V_{DS}=V_{GS}, I_D=250\mu A$	2	3	4	V

Pulse width $t_p \leq 300\mu s, \delta \leq 2\%$

Dynamic Characteristics

Symbol	Parameter	Test Conditions	Values			Units
			Min	Typ	Max	
C_{iss}	Input Capacitance	$V_{DS}=50V,$ $V_{GS}=0,$ $f=1MHz$	--	11260	--	pF
C_{oss}	Output Capacitance		--	1715	--	
C_{rss}	Reverse Transfer Capacitance		--	328	--	
Q_g	Total Gate Charge	$V_{DD}=50V,$ $I_D=100A,$ $V_{GS}=10V$	--	224	--	nC
Q_{gs}	Gate-Source charge		--	80	--	
Q_{gd}	Gate-Drain charge		--	38	--	
R_G	Gate resistance	$V_{GS}=0, V_{DS}=0$		3.6		Ω

Switching Characteristics

Symbol	Parameter	Test Conditions	Values			Units
			Min	Typ	Max	
$t_{d(on)}$	Turn-On Delay Time	$V_{DD}=50V,$ $I_D=10A,$ $V_{GS}=10V,$ $R_G=3\Omega,$ Resistive Load	--	34	--	ns
t_r	Rise Time		--	26	--	
$t_{d(off)}$	Turn-Off Delay Time		--	78	--	
t_f	Fall Time		--	30	--	

Source-Drain Diode Characteristics

Symbol	Parameter	Test Conditions	Values			Units
			Min	Typ	Max	
I_S	Continuous Source Current		--	--	326	A
I_{SM}	Maximum Pulsed Current		--	--	1304	A
V_{SD}	Diode Forward Voltage	$V_{GS}=0V, I_S=50A$	--	--	1.2	V
T_{rr}	Reverse Recovery Time	$I_S=100A, V_{GS}=0,$ $di/dt=100A/us$	--	100	--	ns
Q_{rr}	Reverse Recovery Charge		--	280	--	nC

5. Characteristics Curves

Figure 1. Safe Operating Area

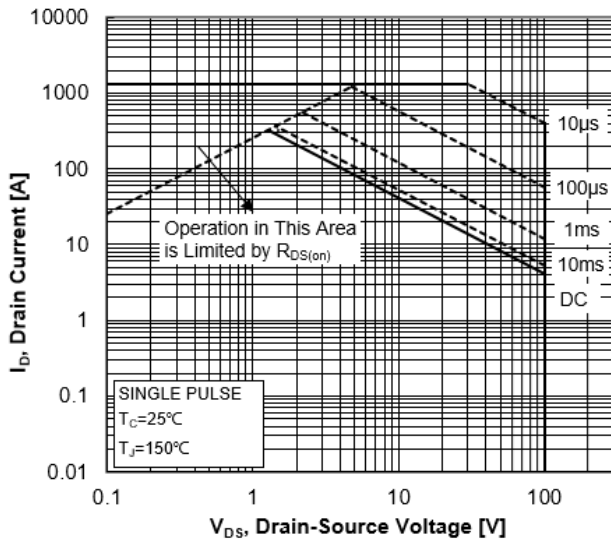

Figure 2. Maximum Power Dissipation vs Case Temperature

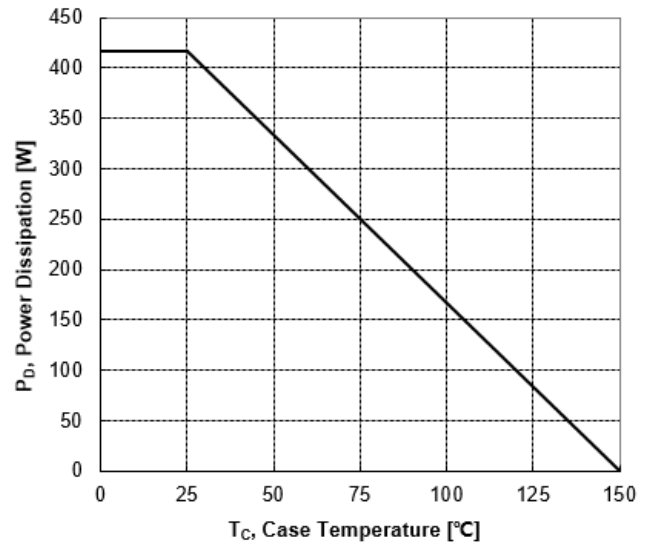

Figure 3. Maximum Continuous Drain Current vs Case Temperature

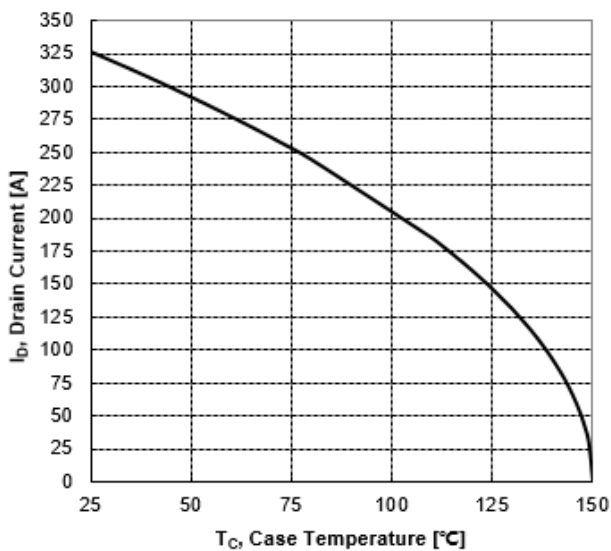

Figure 4. Typical Output Characteristics

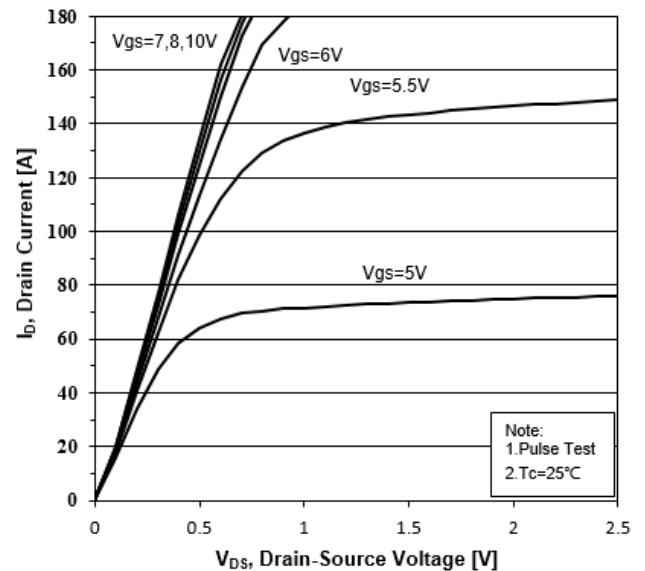

Figure 5. Transient Thermal Impedance

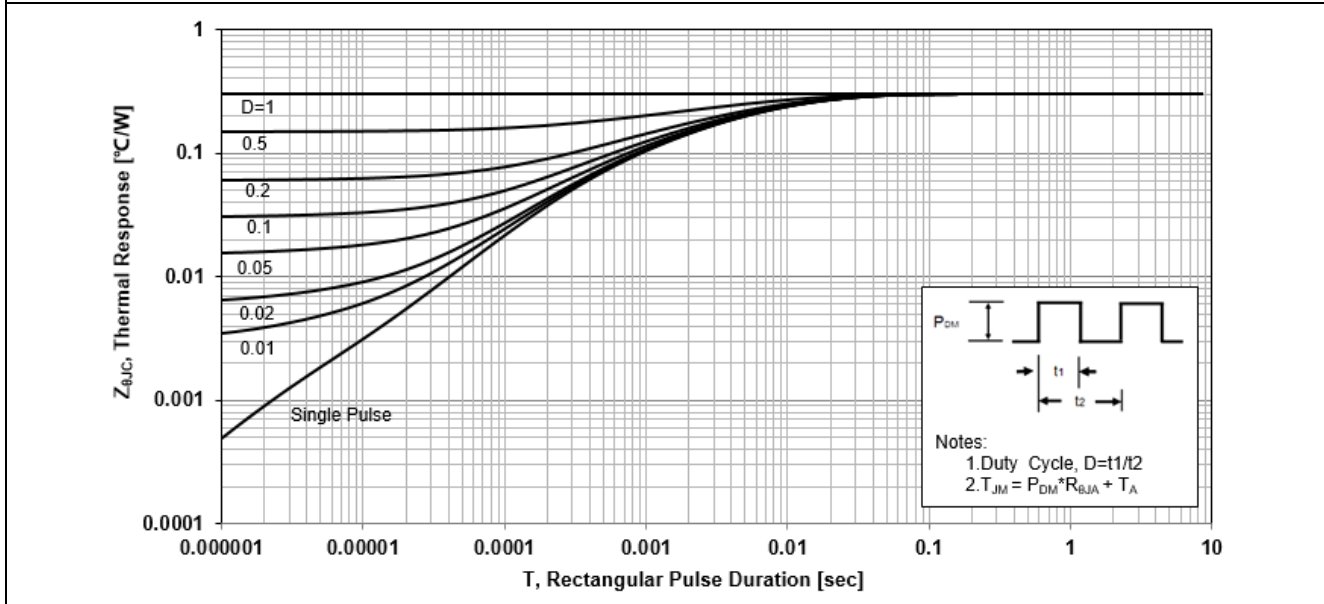

Figure 6. Typical Transfer Characteristics

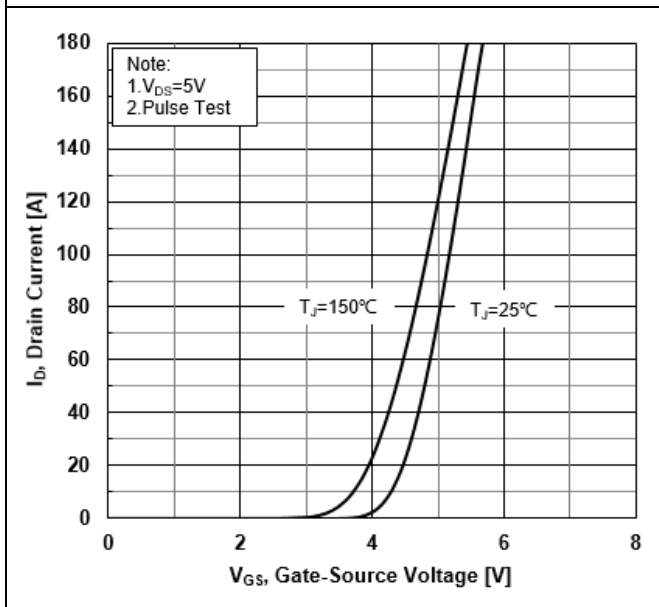

Figure 7. Source-Drain Diode Forward Characteristics

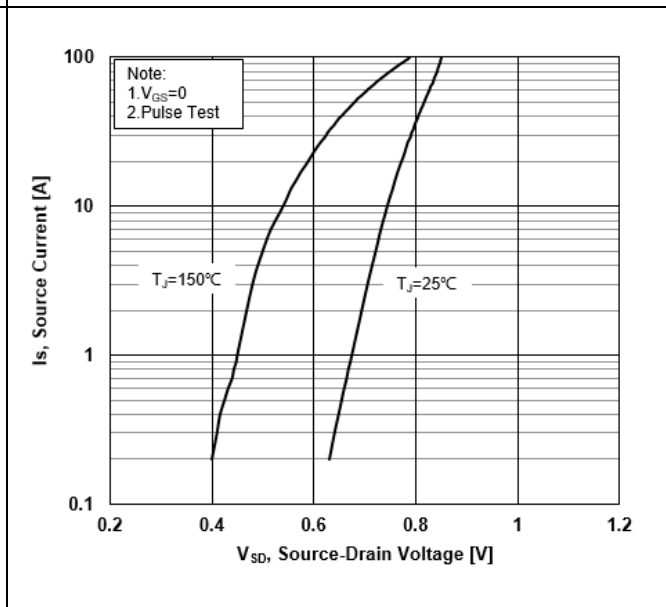

Figure 8. Drain-Source On-Resistance vs Drain Current

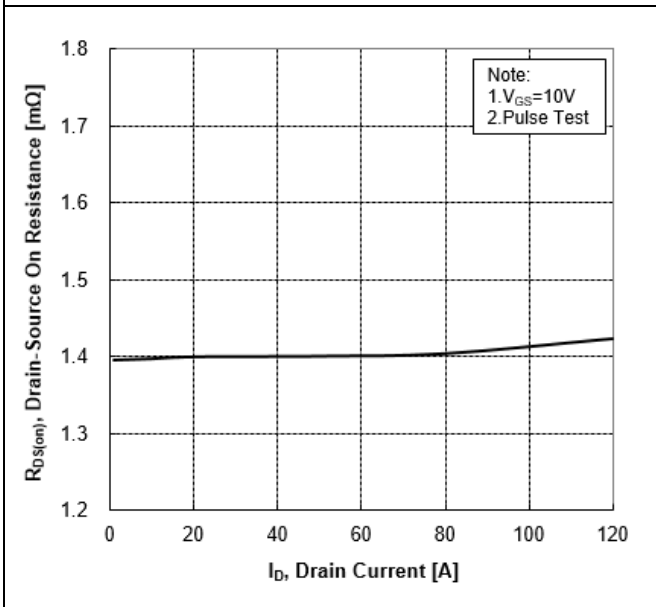

Figure 9. Normalized On-Resistance vs Junction Temperature

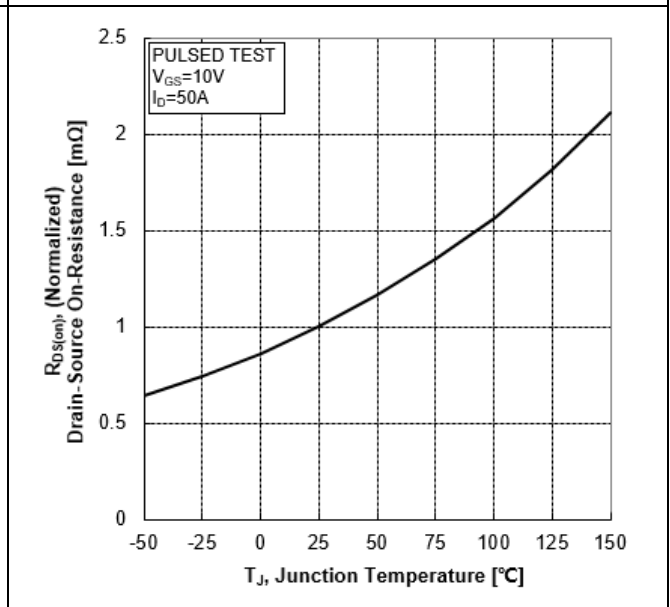

Figure 10. Normalized Threshold Voltage vs Junction Temperature

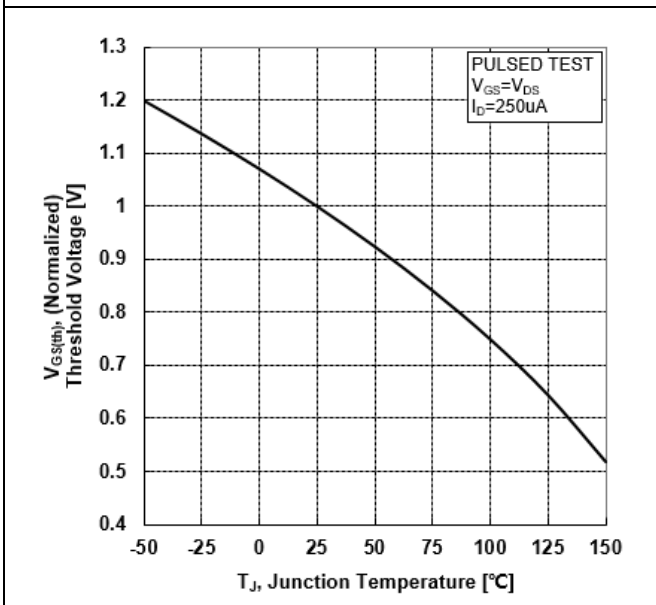

Figure 11. Normalized Breakdown Voltage vs Junction Temperature

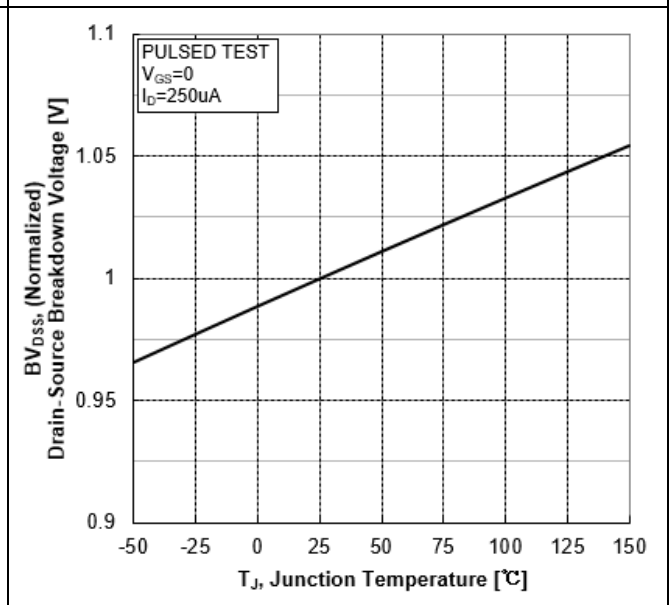

Figure 12. Capacitance Characteristics

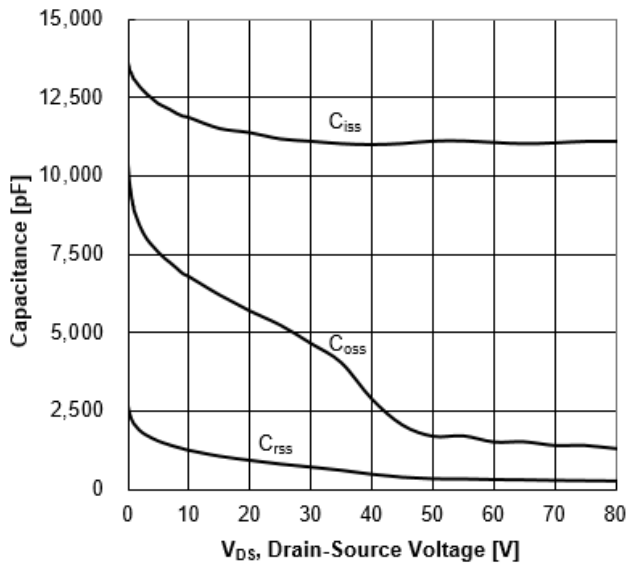
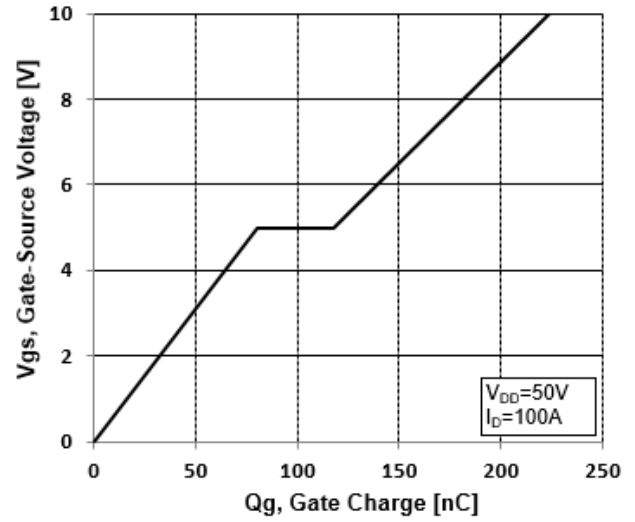

Figure 13. Typical Gate Charge vs Gate-Source Voltage



6. Test Circuit and Waveform

Figure 14. Resistive Switching Test Circuit

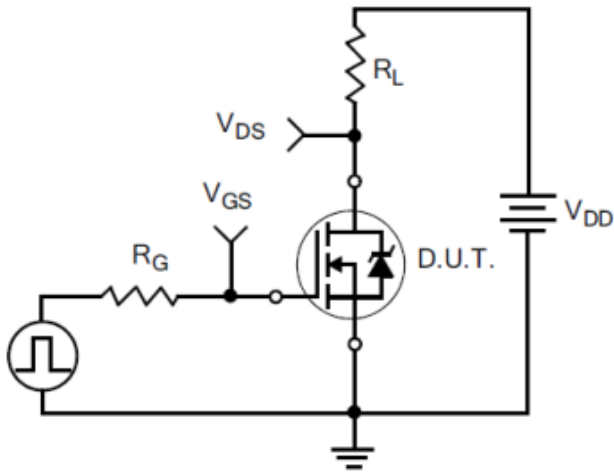

Figure 15. Resistive Switching Waveforms

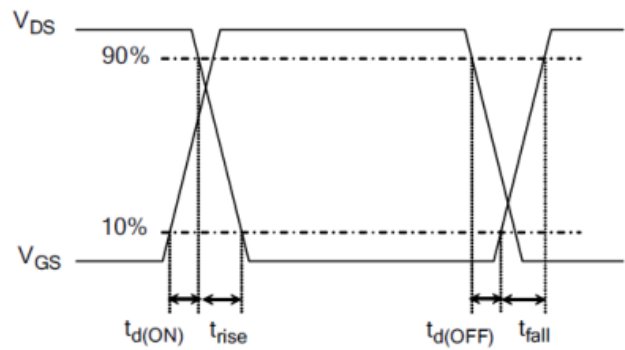

Figure 16. Gate Charge Test Circuit

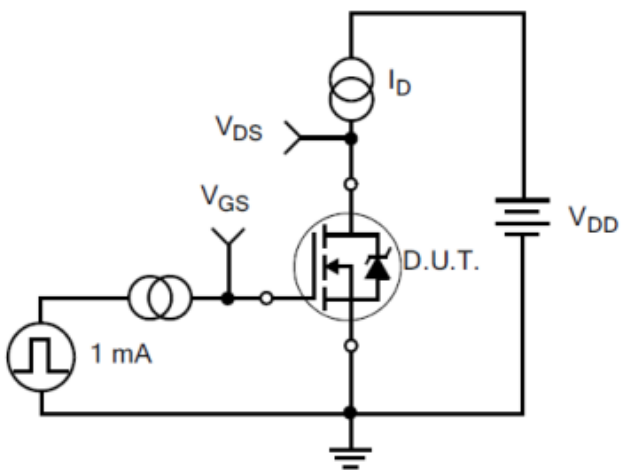
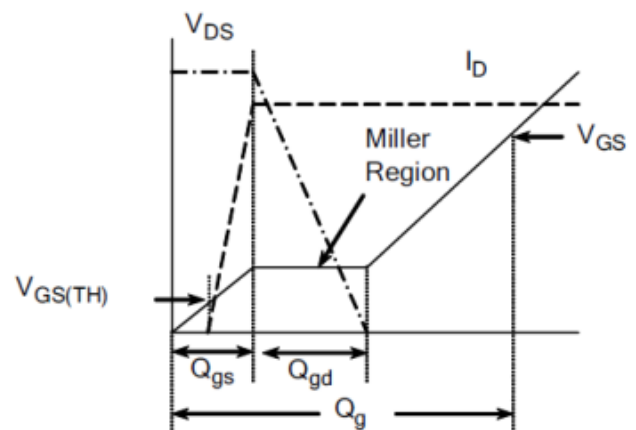
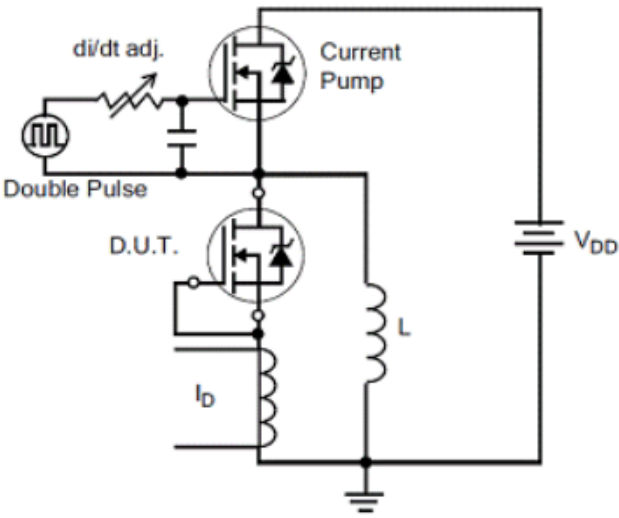
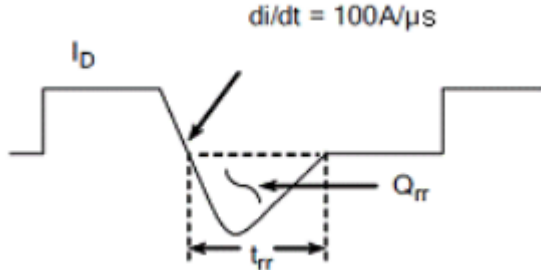
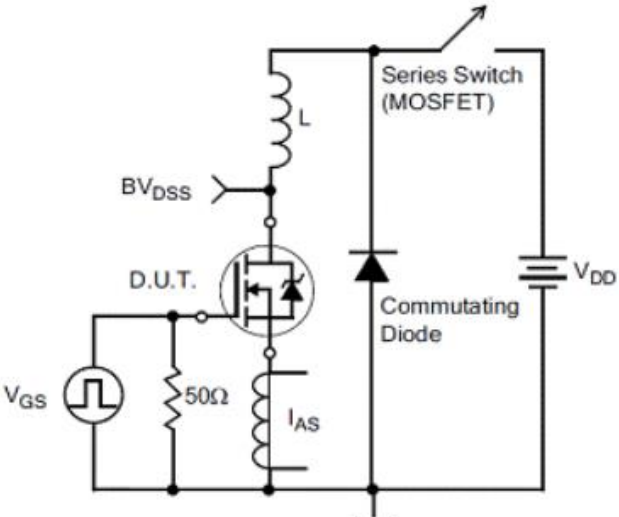
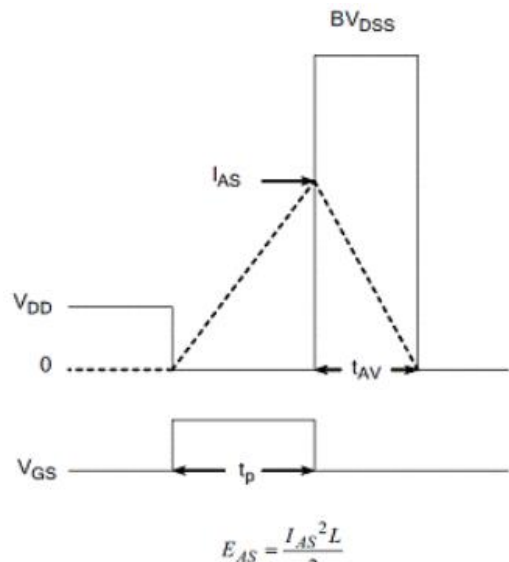

Figure 17. Gate Charge Waveforms



<p>Figure 18. Diode Reverse Recovery Test Circuit</p> 	<p>Figure 19. Diode Reverse Recovery Waveform</p> 
<p>Figure 20. Unclamped Inductive Switching Test Circuit</p> 	<p>Figure 21. Unclamped Inductive Switching Waveform</p>  $E_{AS} = \frac{I_{AS}^2 L}{2}$

7. Package Description

TOLL-8

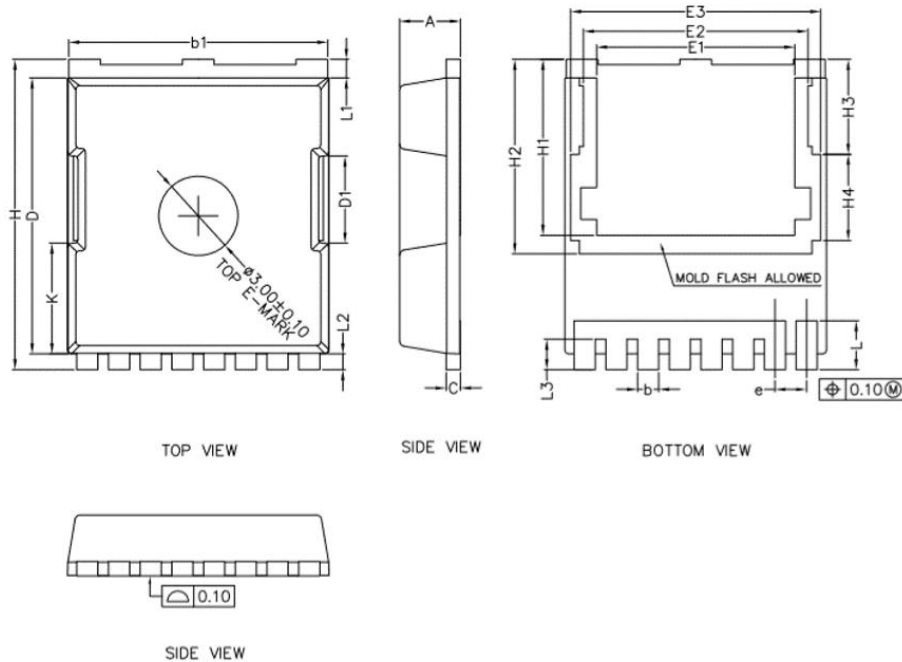

SYMBOL	MIN	NOM	MAX
A	2.20	2.30	2.40
b	0.70	0.80	0.90
b1	9.70	9.80	9.90
c	0.40	0.50	0.60
D	10.28	10.43	10.58
D1	3.15	3.30	3.45
E	9.70	9.90	10.10
E1	7.35	7.50	7.65
E2	8.35	8.50	8.65
E3	9.31	9.46	9.61
e	1.10	1.20	1.30
H	11.48	11.73	11.88
H1	6.55	6.65	6.75
H2	7.20	7.35	7.50
H3	3.44	3.59	3.74
H4	3.11	3.26	3.41
K	4.03	4.18	4.33
L	1.60	1.85	2.10
L1	0.55	0.70	0.85
L2	0.45	0.60	0.75
L3	1.00	1.15	1.30

NOTE:

1. Exceeding the maximum ratings of the device in performance may cause damage to the device, even the permanent failure, which may affect the dependability of the machine. Please do not exceed the absolute maximum ratings of the device when circuit designing.
2. When installing the heat sink, please pay attention to the torsional moment and the smoothness of the heat sink.
3. MOSFETs is the device which is sensitive to the static electricity, it is necessary to protect the device from being damaged by the static electricity when using it.
4. Shanghai Belling reserves the right to make changes in this specification sheet and is subject to change without prior notice.

CONTACT:

上海贝岭股份有限公司（总部）

地址：上海市宜山路 810 号

邮编：200233

电话：021-24261000

产品业务咨询及技术支持

电话：021-24261326

传真：021-64852222

邮箱：marketing@belling.com.cn

上海贝岭深圳分公司（华南区）

地址：深圳市福田区中心区民田路新华保险大厦 1510 室

邮编：518031

电话：0755-33336776 0755-33336770

传真：0755-33336788

上海贝岭北京办事处（华北区）

地址：北京市西城区新华里 16 号院锦官苑小区 10 号楼 1 单元 1505 室

邮编：100044

电话：010-64179374

传真：010-8835 9236