



LC1486

600mA High PSRR, Fast Response Linear Regulator

DESCRIPTION

LC1486 series is a group of positive voltage output, low power consumption, low dropout voltage regulator.

LC1486 can provide output value adjustable from 0.8V to 5.0V.

LC1486 includes high accuracy voltage reference, error amplifier, current limit circuit and output driver module with discharge capability.

LC1486 has excellent load and line transient response and good temperature characteristics, which can assure the stability of chip and power system. It uses trimming technique to guarantee output voltage accuracy within $\pm 2\%$. And it also provides foldback short-circuit protection, thermal protection and output current limit function.

LC1486 is available in SOT23-5 and SC70-5 packages which are lead free.

FEATURES

- Low Power Consumption: 40uA (Typ.)
- Maximum output current: 600mA
- Low dropout Voltage:
 - 170mV@Iout=300mA, Vout=3.3V
 - 355mV@Iout=600mA, Vout=3.3V
- Build-in chip enable and discharge circuit
- Input voltage range: 2.5~6V
- Adjustable Output from 0.8V to 5.0V
- Output Voltage Accuracy: $\pm 2\%$
- Output current limit: 1A (Typ.)
- OCP/SCP/TSD protection

APPLICATIONS

- Power source for cellular phones and various kind of PCSs
- Battery Powered equipment
- Power Management of MP3, PDA, DSC, Mouse, PS2 Games
- Reference Voltage Source
- Regulation after Switching Power

TYPICAL APPLICATION

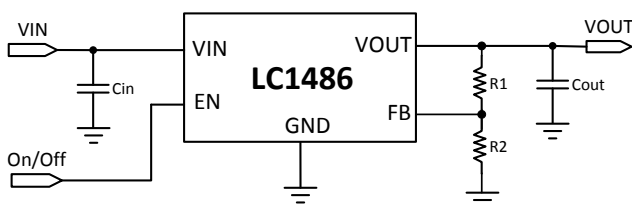

Note:

1) Input capacitor ($C_{in}=1\mu F$) and Output capacitor ($C_{out}=1\mu F$) are recommended in all application circuit.

2) $V_{OUT}=V_{FB}*(1+\frac{R1}{R2})$, $V_{FB}=0.8V$

PIN OUT & MARKING

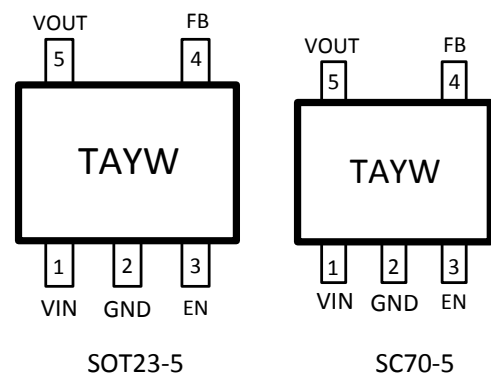

TA: Product Code

YW: Date code (Year & Week)

ORDERING INFORMATION

PART No.	PACKAGE	Tape&Reel
LC1486CB5TR	SOT23-5	3000/Reel
LC1486CA5TR	SC70-5	3000/Reel

ABSOLUTE MAXIMUM RATING

Parameter	Value	
Max Input Voltage	8V	
Operating Junction Temperature(Tj)	150°C	
Ambient Temperature(Ta)	-40°C –85°C	
Power Dissipation	SOT23-5	400mW
	SC70-5	400mW
Storage Temperature(Ts)	-40°C -150°C	
Lead Temperature & Time	260°C,10S	

Note: Exceed these limits to damage to the device. Exposure to absolute maximum rating conditions may affect device reliability.

RECOMMENDED WORK CONDITIONS

Parameter	Value
Input Voltage Range	2.5V to 6V
Ambient Temperature	-40°C –85°C

ELECTRICAL CHARACTERISTICS

(Test Conditions: C_{IN}=1uF, C_{OUT}=1uF, T_A=25°C, unless otherwise specified.)

Symbol	Parameter	Conditions	Min	Typ	Max	Units
V _{IN}	Input Voltage		2.5		6	V
V _{FB}	Regulated Feedback Voltage	V _{IN} =3.3V, I _{OUT} =10mA	0.784	0.8	0.816	V
V _{DROP} *	Dropout Voltage	V _{OUT} =1.8V, I _{OUT} =300mA		900	1350	mV
		V _{OUT} =2.5V, I _{OUT} =600mA		550	825	mV
		V _{OUT} =3.3V, I _{OUT} =600mA		355	500	mV
$\frac{\Delta V_{out}}{\Delta V_{in} \cdot V_{out}}$	Line Regulation	I _{OUT} =10mA, 2.5V≤V _{IN} ≤6V		0.05	0.2	%/V
$\frac{\Delta V_{out}}{\Delta I_{out}}$	Load Regulation	V _{IN} =4.3V, V _{OUT} =3.3V 0mA≤I _{OUT} ≤600mA		50	80	mV
I _Q	Supply Current	V _{IN} = V _{OUT} +1V		40	100	uA
I _{STANDBY}	Supply Current (Standby)	V _{IN} = V _{OUT} +1V, V _{EN} =GND		0.1	1.0	uA
$\frac{\Delta V_{out}}{\Delta T \cdot V_{out}}$	Output Voltage Temperature Coefficiency	I _{OUT} =10mA		±100		ppm/°C
PSRR	Ripple Rejection	F=1KHz, Ripple=1Vp-p V _{IN} = V _{OUT} +1V		60		dB
I _{LIM}	Current Limit	V _{IN} =4.3V, V _{OUT} =3.3V		1		A
I _{SHORT}	Short Current Limit	V _{OUT} =0V		200		mA
R _{DISCHARGE}	Discharge Resistor	EN=0, V _{OUT} =3V		280		ohm
V _{ENH}	EN Input Voltage “H”		1.3		V _{in}	V
V _{ENL}	EN Input Voltage “L”		0		0.35	V
T _{SD}	Thermal Shutdown Temp			160		°C

LC1486

T_{SH}	Thermal Shutdown Hysteresis		30	°C
----------	-----------------------------	--	----	----

Note: * $V_{DROP} = V_{IN1} - (V_{OUT2} * 0.98)$ V_{OUT2} is the output voltage when $V_{IN} = V_{OUT1} + 1.0V$ and $I_{OUT} = 600mA$. V_{IN1} is the input voltage at which the output voltage becomes 98% of V_{OUT1} after gradually decreasing the input voltage.

PIN DESCRIPTION

PIN #	NAME	DESCRIPTION
1	VIN	Supply Voltage Input. Supply voltage can range from 1.8V to 6V. Bypass with a 1μF capacitor to GND.
2	GND	Ground Pin
3	EN	Enable Pin. This pin has an internal pull-down resistor. A logic low reduces the supply current to less than 1μA. Connect to IN for normal operation.
4	FB	Feedback Pin (adjustable voltage version only). This is used to set the output voltage of the device.
5	VOUT	Output Voltage

BLOCK DIAGRAM

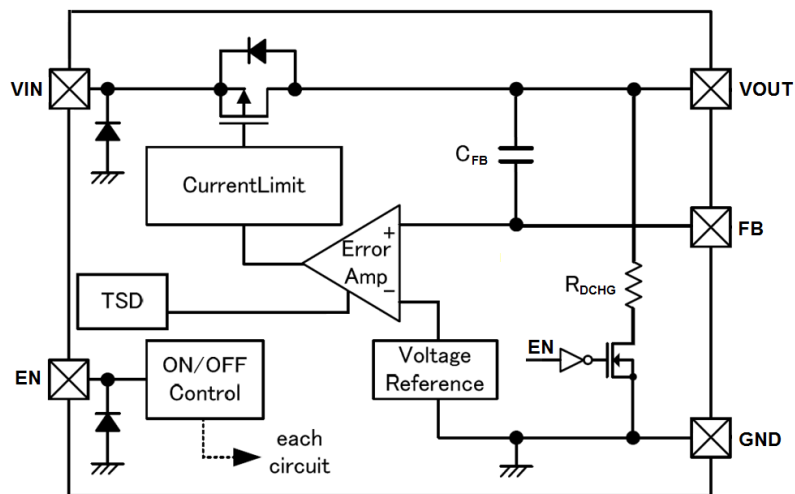

EXPLANATION

LC1486 series is a group of positive voltage output, low noise, low power consumption, low dropout voltage regulator.

LC1486 can provide output value adjustable from 0.8V to 5.0V.

LC1486 includes high accuracy voltage reference, error amplifier, current limit circuit and output driver module.

LC1486 has excellent load and line transient response and good temperature characteristics, which can assure the stability of chip and power system. It uses trimming technique to guarantee output voltage accuracy within $\pm 2\%$. And it also provides fold-back short-circuit protection, thermal protection and output current limit function.

TYPICAL PERFORMANCE CHARACTERISTICS

Load Regulation
(Vout=1.8V)

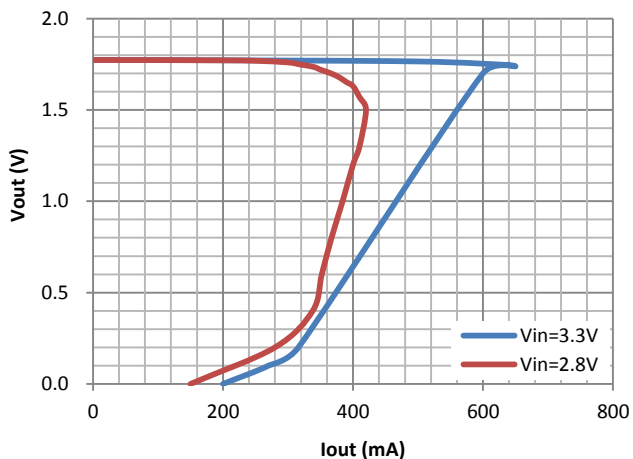

Load Regulation
(Vout=3.3V)

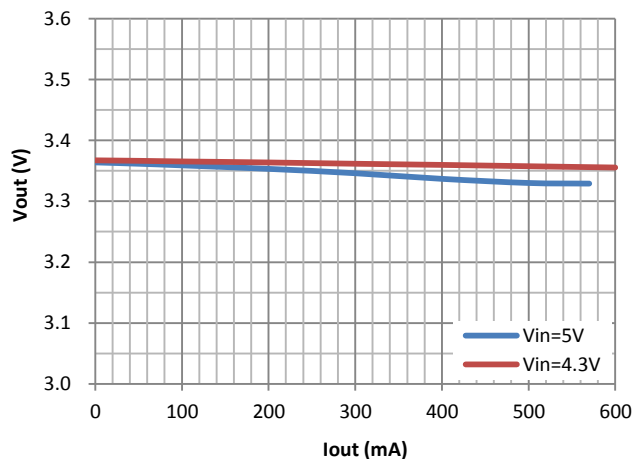

Line Regulation
(Vout=1.8V)

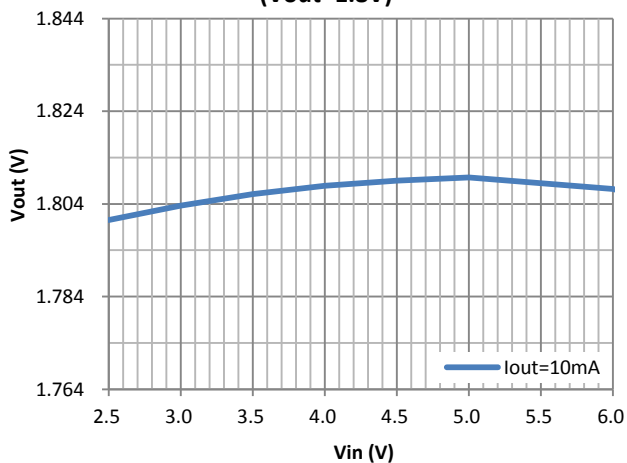

Line Regulation
(Vout=3.3V)

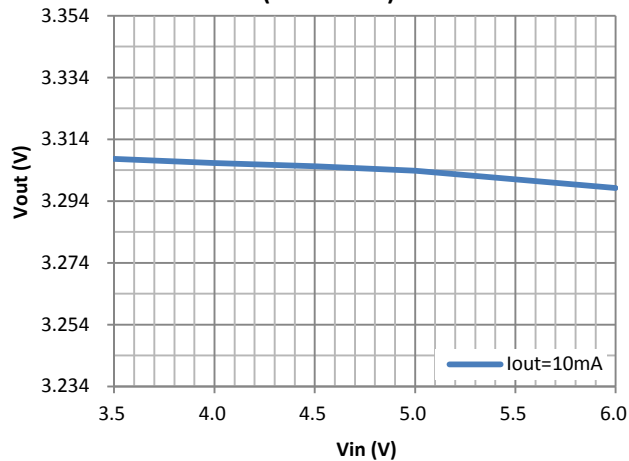

Dropout Voltage

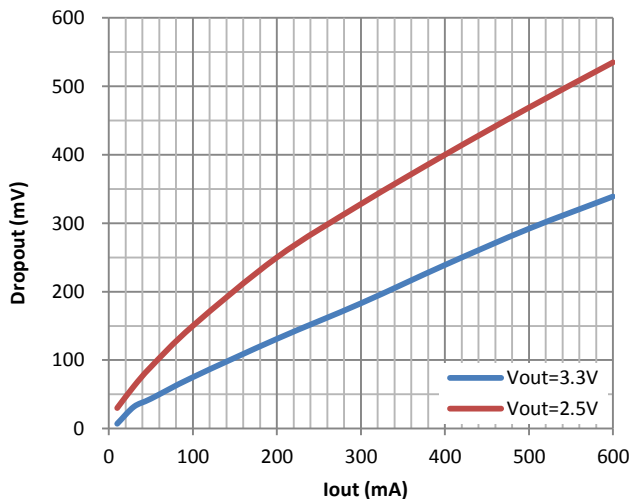

Dropout Voltage vs. Temp
(Vout=3.3V)

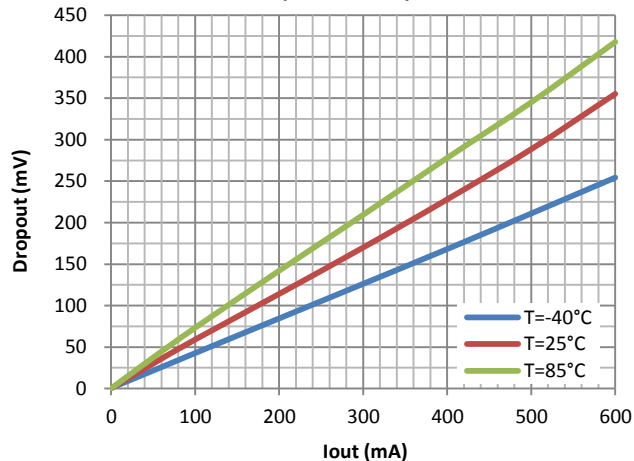

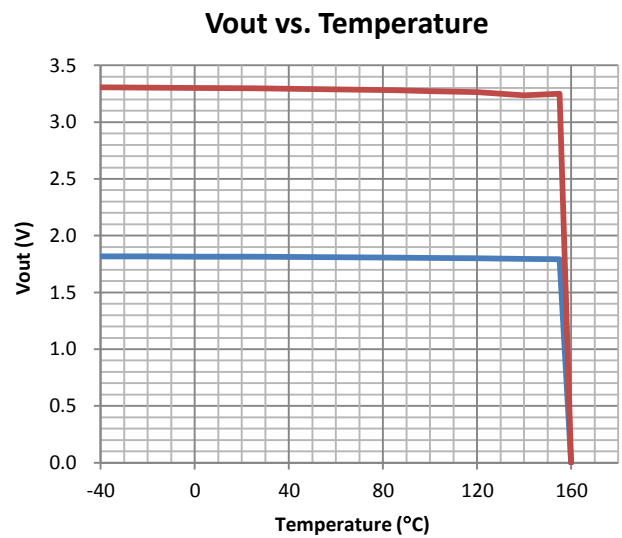
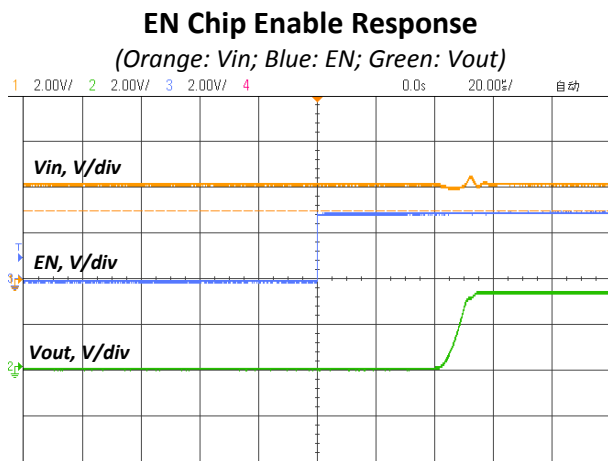
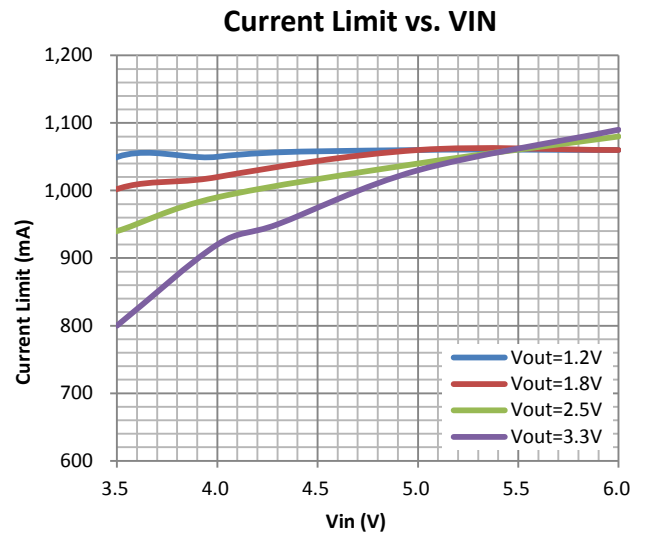
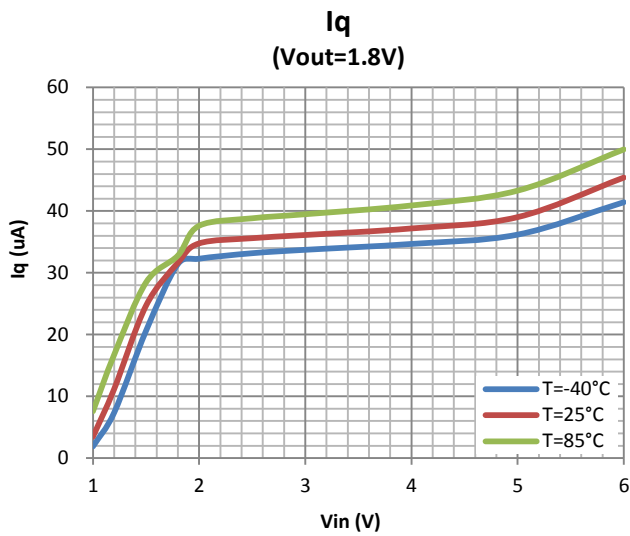

Line Transient Response

Vout=3.3V, Iout=10mA
 Vin=4.3-5.3V, Vout p-p=78mV
 (Orange: Vin; Green: Vout)

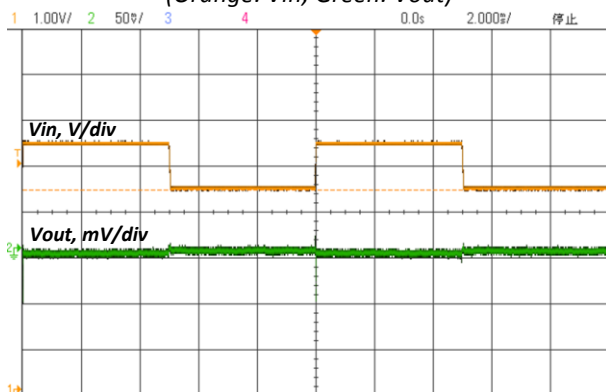

Load Transient Response

Vin=4.3V, Vout=3.3V, Iout=10-600mA
 Trise=1uS, Tfall=1uS, Vout p-p=74mV
 (Pink: Iout; Orange: Vout)

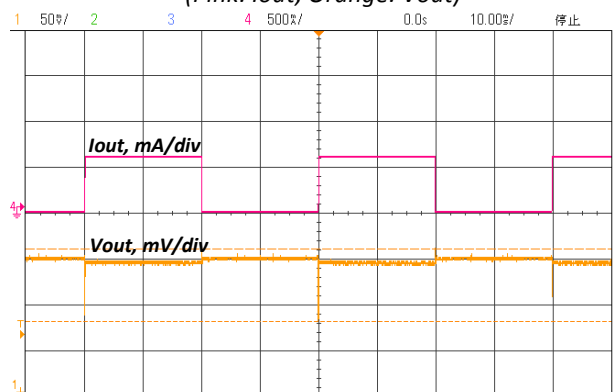

PACKAGE OUTLINE

Package	SOT-23-5	Devices per reel	3000Pcs	Unit	mm
Package Dimension:					
<p>Technical drawing of the SOT-23-5 package. The top view shows a rectangular body with a total width of 2.9 ± 0.2 mm and a body width of 1.9 ± 0.2 mm. The distance between the two leads on the top is 0.95 mm. The lead width is 0.4 ± 0.1 mm. The body height is 1.6 ± 0.1 mm, and the total height including leads is 2.8 ± 0.3 mm. The side view shows a lead height of 1.1 ± 0.2 mm, a lead thickness of 0.8 ± 0.1 mm, and a lead width of 0.15 ± 0.1 mm. The lead angle is 0.2 MIN. The bottom view shows a perspective of the package with five leads labeled 1 through 5.</p>					

Package	SC70-5	Devices per reel	3000Pcs	Unit	mm
Package dimension:					
<p>Technical drawing of the SC70-5 package. The top view shows a rectangular body with a total width of 2.025 ± 0.025 mm and a body height of 1.25 ± 0.1 mm. The distance between the two leads on the top is 0.275 ± 0.125 mm. The side view shows a lead height of 0.17 ± 0.09 mm, a lead thickness of 0.335 ± 0.125 mm, and a lead width of 0.95 ± 0.15 mm. The lead angle is 0.1 mm. The bottom view shows a perspective of the package with five leads.</p>					