

GENERAL DESCRIPTION

LC1482 series are a group of positive voltage output, high precise, and low power consumption voltage regulator. Voltages are selectable in 100mV steps within a range of 1.2V to 5.0V. It also can be customized on command.

LC1482 series have excellent load and line transient response and good temperature characteristics, which can assure the stability of chip and power system. And it uses trimming technique to guarantee output voltage accuracy within $\pm 2\%$.

LC1482 series are available in SOT-23-5 package, which is lead (Pb)- free.

FEATURES

- Low Quiescent Current: 100uA at 5V
- High PSRR: 65dB range to 1KHz
- Low Output Noise: 44uVRMS
- Low Dropout: 200mV@Iout=0.8A, Vout=3.3V
- Maximum output current: 1A
- Highly Accurate: $\pm 2\%$
- Low ESR Ceramic Capacitor Compatible

APPLICATIONS

- Reference Voltage Source
- Battery Powered Equipment
- PC Peripherals
- Wireless Devices
- Instrumentation

TYPICAL APPLICATION

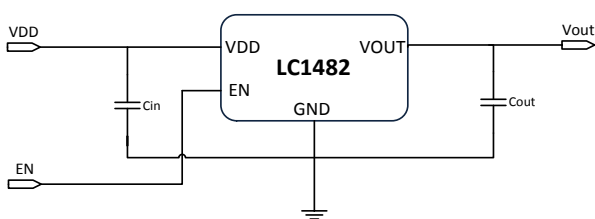

BLOCK DIAGRAM

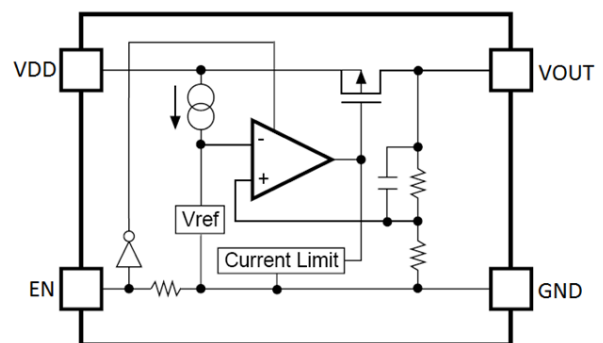

ORDERING INFORMATION

LC1482 ①②③④⑤

Code	Description
①	Temperature&Rohs: C:-40~85°C ,Pb Free Rohs Std.
②	Package type: B5:SOT-23-5
③	Packing type: TR:Tape&Reel (Standard)
④	Output voltage: e.g. 12=1.2V 18=1.8V 25=2.5V 33=3.3V 50=5.0V
⑤	Voltage accuracy: 1=±1%(Customized) Blank(default)=±2%

MARKING DESCRIPTON

Output Voltage Code X

VOUT	Code	VOUT	Code	VOUT	Code
1.2V	2	2.9V	9	4.3V	3
1.3V	3	3.0V	0	4.4V	4
1.4V	4	3.1V	1	4.5V	5
1.5V	5	3.2V	2	4.6V	6
1.8V	8	3.3V	3	4.7V	7
2.0V	0	3.4V	4	4.8V	8
2.1V	1	3.5V	5	4.9V	9
2.2V	2	3.6V	6	5.0V	0
2.3V	3	3.7V	7	5.1V	1
2.4V	4	3.8V	8	5.2V	2
2.5V	5	3.9V	9	5.3V	3
2.6V	6	4.0V	0	5.4V	4
2.7V	7	4.1V	1	5.5V	5
2.8V	8	4.2V	2		

XX: Output Voltage, e.g. 18=1.8V 33=3.3V

Y: The Year of manufacturing, "1" stands for year 2011, "2" stands for year 2012, and "8" stands for year 2018.

W: The week of manufacturing. "A" stands for week 1, "Z" stands for week 26, "A" stands for week 27, "Z" stands for week 52.

PIN CONFIGURATION

Product Classification		LC1482CB5TR□□
JBXYW	JB:Product Code	
	X:Output Voltage	
	YW:Date Code	
VDD	Supply Voltage Input	
GND	Ground Pin	
EN	Chip Enable	
NC	No Connection	
VOUT	Output Voltage	

ABSOLUTE MAXIMUM RATING

Parameter	Value
Max Input Voltage	8V
Max Operating Junction Temperature (T _J)	145°C
Ambient Temperature (T _A)	-40°C~85°C
Power Dissipation	SOT-23-5 250mW
Storage Temperature (T _S)	-40°C~150°C
Lead Temperature & Time	260°C, 10 Sec

RECOMMENDED WORK CONDITIONS

Parameter	Value
Input Voltage Range	Max. 6V
Ambient Temperature	-40°C~85°C
Operating Junction Temperature (T _J)	125°C

ELECTRICAL CHARACTERISTICS

Test Conditions: $C_{IN}=4.7\mu F, C_{OUT}=4.7\mu F, T_A=25^\circ C$, unless otherwise specified.

Symbol	Parameter	Conditions	Min	Typ	Max	Units
V_{DD}	Input Voltage		1.5*		6	V
V_{OUT}	Output Voltage	$V_{OUT}>1.5$	$V_{DD}=\text{Set } V_{OUT}+1V$	V_{OUT}	$V_{OUT} \times 1.02$	V
		$V_{OUT} \leq 1.5$	$1mA \leq I_{OUT} \leq 10mA$		$V_{OUT} + 0.03$	
$I_{OUT} \text{ (Max.)}^{**}$	Maximum Output Current	$V_{DD}-V_{OUT}=1V$	1			A
V_{DROP}	Dropout Voltage	$V_{OUT}=3.3V, I_{OUT}=1A$		300	500	mV
$\frac{\Delta V_{out}}{\Delta V_{in} \cdot V_{out}}$	Line Regulation	$I_{OUT}=10mA, 4V \leq V_{DD} \leq 6V$		0.05	0.2	%/V
ΔV_{out}	Load Regulation	$V_{DD}=\text{Set } V_{OUT}+1V$ $1mA \leq I_{OUT} \leq 2.5A$		30	60	mV
I_s	Supply Current	$V_{DD}=\text{Set } V_{OUT}+1V, V_{OUT}$ Floating		100	150	μA
$\frac{\Delta V_{out}}{\Delta T \cdot V_{out}}$	Output Voltage Temperature Coefficient	$I_{OUT}=10mA$		± 100		ppm/ $^\circ C$
PSRR	Ripple Rejection	$f=100Hz, \text{Ripple}=0.5Vp-p,$ $V_{DD}=\text{Set } V_{OUT}+1V$		65		dB
R_{pd}	EN Pull down Resistance			5		$M\Omega$
V_{enh}	EN Input Voltage "H"		0.95		V_{in}	V
V_{enl}	EN Input Voltage "L"		0		0.25	V
en	Output Noise	$BW=10Hz \sim 100KHz$		44		μV_{rms}

Note: * $I_{out}=350mA @ V_{in}=1.5V, V_{out}=1.2V$

**The maximum power rating of each package is a constant, so along with the change of I_{LOAD} , the $V_{DD}-V_{OUT}$ should be controlled to a certain range to ensure the normal operation.

TYPICAL PERFORMANCE CHARACTERISTICS

Load Regulation
($V_{out}=3.3V$)

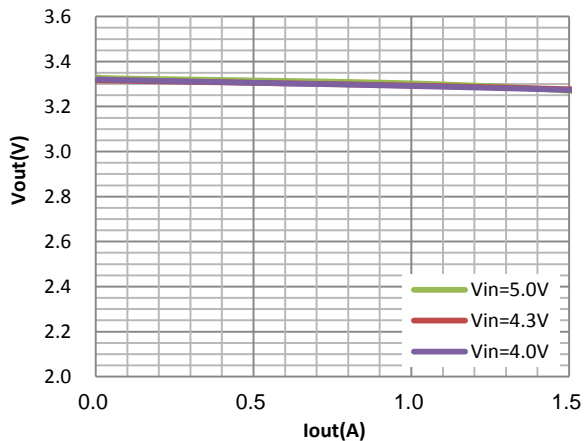

Safe Operation Area
($V_{out}=3.3V$)

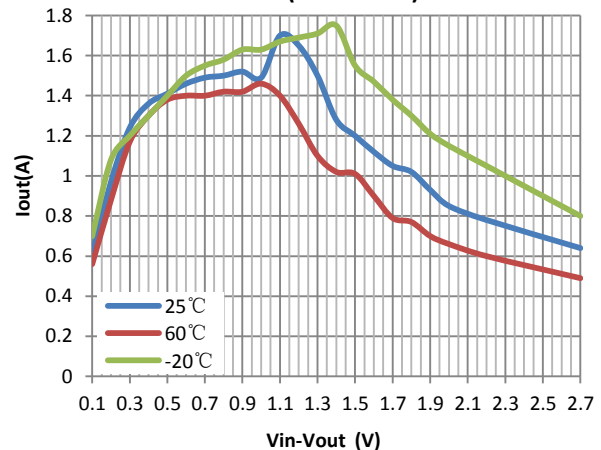

Line Regulation

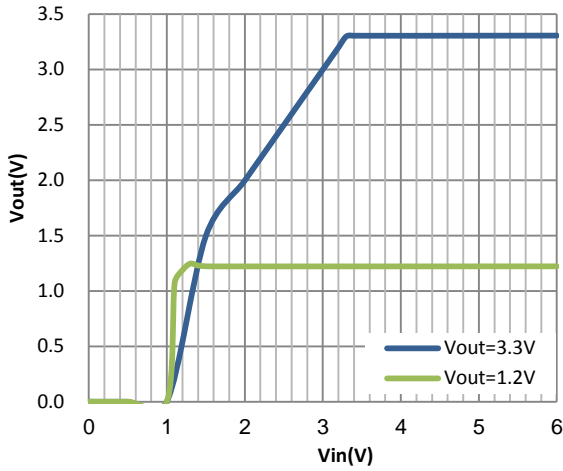

Iq

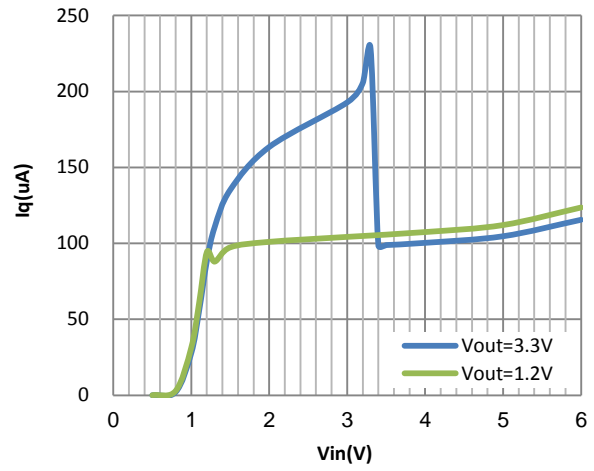

Dropout Voltage

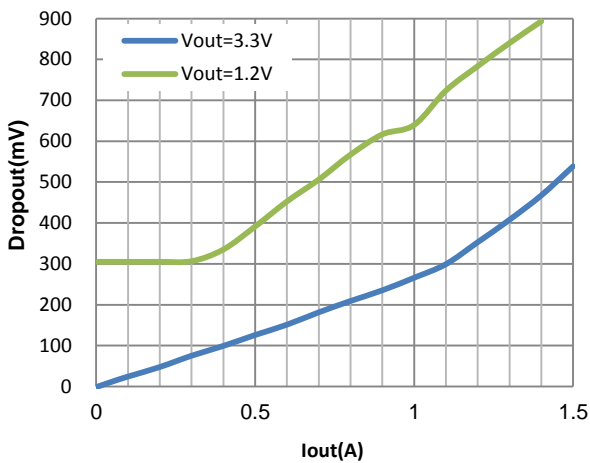

Vout vs. Temperature

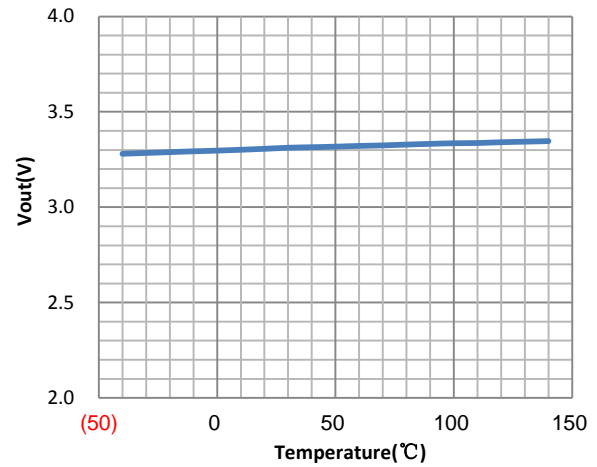

Load Transient Response (Vin=5V, Vout=3.3V) Cin=1uF, Cout=1uF, Iout=1mA-100mA

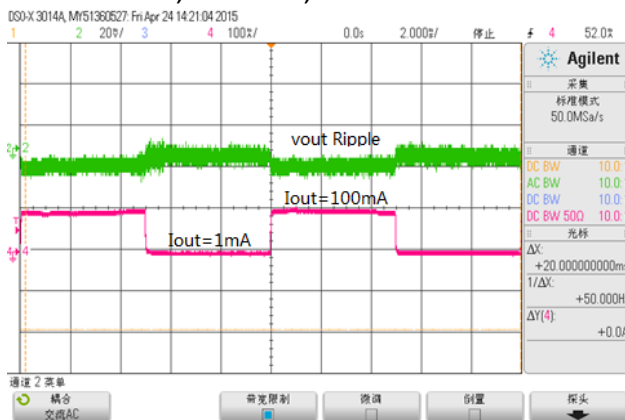

Line Transient Response (Vin=5V, Vout=3.3V) Cin=1uF, Cout=1uF, Iout=10mA, Vin=4.3V-5.3V

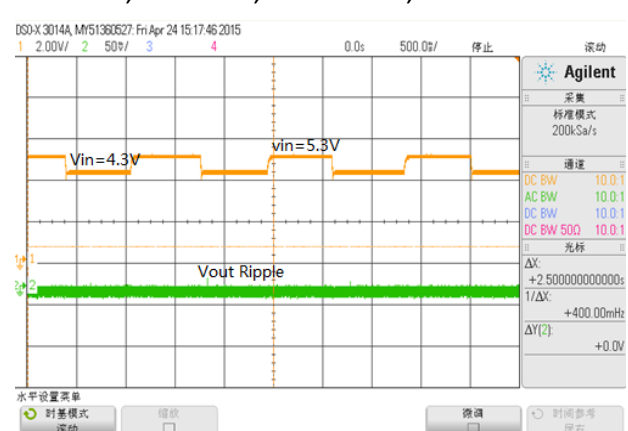

PACKAGE LINE

Package	SOT-23-5	Devices per reel	3000Pcs	Unit	mm
<p>Package Dimension:</p> <p>The drawing shows the following dimensions:</p> <ul style="list-style-type: none"> Top view: Total width 2.9 ± 0.2 mm, distance between pins 1 and 5 1.9 ± 0.2 mm, and individual pin pitch of 0.95 mm. Side view: Total height 2.8 ± 0.3 mm, distance from top edge to pin 1 1.6 ± 0.2 mm, and pin height 0.4 ± 0.1 mm. Pin 1: Width 1.1 ± 0.2 mm, height 0.8 ± 0.1 mm, and thickness 0.15 ± 0.1 mm. Pin 2: Minimum thickness 0.2 mm. Lead thickness: 0 to 0.1 mm. 					