



# LC1218

## 250mA Low Consumption Linear Regulator

### DESCRIPTION

LC1218 series is a group of positive voltage output, low power consumption, low dropout voltage, three terminal regulator. It can provide 200mA output current when input / output voltage differential drops to 420mV (  $V_{out}=3.3V$  ), And it also provides foldback short-circuit protection and output current limit function. The very low power consumption of LC1218 (  $I_q=2.0\mu A$  ) can greatly improve natural life of batteries.

LC1218 can provide output value in the range of 1.1V~5.0V in 0.1V steps. It also can customized on command.

LC1218 includes high accuracy voltage reference, error amplifier, current limit circuit and output driver module.

LC1218 has well load transient response and good temperature characteristic, And it uses trimming technique to guarantee output voltage accuracy within  $\pm 2\%$ .

### TYPICAL APPLICATION

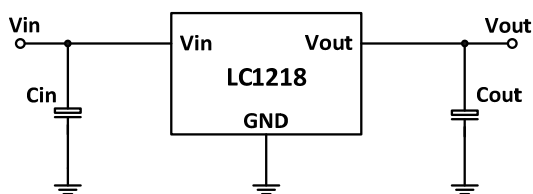

**NOTE:** Input capacitor ( $C_{in}=1\mu F$ ) and Output capacitor ( $C_{out}=1\mu F$ ) are recommended in all application circuit. Ceramic capacitor is recommended.

### FEATURES

- Low Power Consumption:  $2.0\mu A$  ( Typ. )
- Maximum Output Current: 250mA
- Small Dropout Voltage  
 $210mV@100mA$  ( $V_{out}=3.3V$ )  
 $420mV@200mA$  ( $V_{out}=3.3V$ )
- Input Voltage Range:  $2V\sim 16V$
- Output Voltage Range:  $1.1V\sim 5.0V$  (customized on command in 0.1V steps)
- Highly Accurate:  $\pm 2\%$  ( $\pm 1\%$  customized )
- Output Current Limit  
 $330mA@V_{out}=3.3V$
- Foldback Short-circuit Current  
 $56mA@V_{out}=3.3V$

### APPLICATIONS

- Battery Powered equipment
- Power Management of MP3、PDA、DSC、Mouse、PS2 Games
- Reference Voltage Source Regulation after Switching Power

### ELECTRICAL CHARACTERISTICS

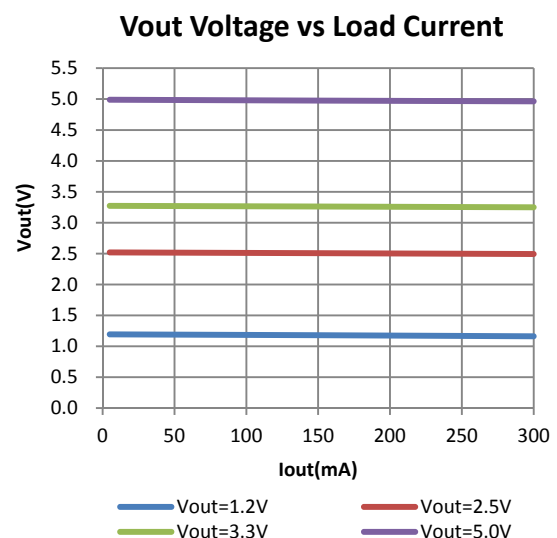

## ORDERING INFORMATION

### LC1218 12345

Code	Description
1	Temperature&Rohs: C: -40~85°C ,Pb Free Rohs Std.
2	Package type: B3:SOT-23-3 B5:SOT-23-5 C3:SOT-89-3 C3B:SOT-89-3 (B)
3	Packing type: TR:Tape&Reel (Standard)
4	Output voltage: e.g. 11=1.1V 15=1.5V 55=5.5V
5	Voltage accuracy: 1= ± 1% Blank(default)= ± 2%

## MARKING DESCRIPTON

M: Product Code

X: Output Voltage

Output Voltage Code

VOUT	Code	VOUT	Code	VOUT	Code
1.1V	1	2.9V	9	4.3V	3
1.2V	2	3.0V	0	4.4V	4
1.3V	3	3.1V	1	4.5V	5
1.5V	5	3.2V	2	4.6V	6
1.8V	8	3.3V	3	4.7V	7
2.0V	0	3.4V	4	4.8V	8
2.1V	1	3.5V	5	4.9V	9
2.2V	2	3.6V	6	5.0V	0
2.3V	3	3.7V	7	5.1V	1
2.4V	4	3.8V	8	5.2V	2
2.5V	5	3.9V	9	5.3V	3
2.6V	6	4.0V	0	5.4V	4
2.7V	7	4.1V	1	5.5V	5
2.8V	8	4.2V	2		

Y: The Year of manufacturing, "1" stands for year 2011, "2" stands for year 2012, and "8" stands for year 2018.  
W: The week of manufacturing. "A" stands for week 1, "Z" stands for week 26, "A" stands for week 27, "Z" stands for week 52.

## PIN CONFIGURATION

Product Classification		LC1218CB3TR□□□
Marking		SOT-23-3
MXYW	M:Product Code	
	X:Output Voltage	
	YW: Date Code	
Product Classification		LC1218CB5TR□□□
Marking		SOT-23-5
MXYW	M:Product Code	
	X: Output Voltage	
	YW: Date Code	
Product Classification		LC1218CC3TR□□□
Marking		SOT-89-3
MXX LLBYW	M:Product Code	
	XX: Output Voltage	
	LL: LOT NO.	
	B:FAB Code	
		YW: Date Code
Product Classification		LC1218CC3BTR□□□
Marking		SOT-89-3
MXXI LLBYW	M:Product Code	
	XX: Output Voltage	
	LL: LOT NO.	
	B:FAB Code	
		YW: Date Code

## ABSOLUTE MAXIMUM RATING

Parameter		Value
Max Input Voltage		20V
Operating Junction Temperature(Tj)		125°C
Ambient Temperature(Ta)		-40°C -85°C
Power Dissipation	SOT-23-3	250mW
	SOT-23-5	250mW
	SOT-89-3	500mW
Storage Temperature(Ts)		-40°C -150°C
Lead Temperature & Time		260°C,10S

**Note:**

Exceed these limits to damage to the device.

Exposure to absolute maximum rating conditions may affect device reliability.

## RECOMMENDED WORK CONDITIONS

Item	Min	Recommended	Max.	Unit
Input Voltage Range			16	V
Ambient Temperature	-40		85	°C

## ELECTRICAL CHARACTERISTICS

(Test Conditions: Cin=1uF, Cout=1uF, TA=25°C, Unless Otherwise Specified)

Symbol	Parameter	Conditions	Min	Type	Max	Units
Vin	Input Voltage				16	V
Vout	Output Voltage		Vout x0.98		Vout X1.02	V
Iout(Max.)	Maximum Output Current	Vin-Vout=1V	250			mA
Dropout Voltage	Input-Output Voltage Differential	Iout=100mA	Vout ≤ 2.5V	600	1000	mV
			Vout ≥ 2.5V	300	600	
$\frac{\Delta V_{out}}{\Delta V_{in} \cdot V_{out}}$	Line Regulation	Iout=10mA 2V ≤ Vin ≤ 16V		0.2	0.3	%/V
$\Delta V_{out}$	Load Regulation	Vin=Set Vout+1V 1mA ≤ Iout ≤ 100mA		20	40	mV
Iq	Quiescent Current	Vin=Set Vout+1V		2.0	5.0	uA
$\frac{\Delta V_{out}}{\Delta T \cdot V_{out}}$	Output Voltage Temperature Coefficient	Iout=10mA		100		ppm/°C

## BLOCK DIAGRAM

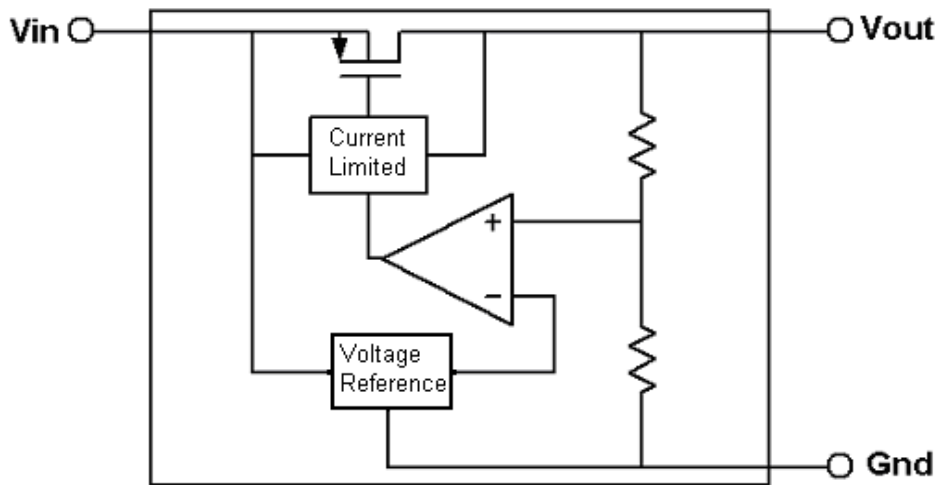

## EXPLANATION

LC1218 is a series of low dropout voltage and low power consumption three pins regulator. Its application circuit is very simple, which only needs two outside capacitors. It is composed of these modules: high accuracy voltage reference, current limit circuit, error amplifier, output driver and power transistor.

Current Limit module can keep chip and power system away from danger when load current is more than 250mA.

LC1218 uses trimming technique to assure the accuracy of output value within  $\pm 2\%$ , at the same time, temperature compensation is elaborately considered in this chip, which makes LC1218's temperature coefficient within  $100\text{ppm}/^\circ\text{C}$ .

## TYPICAL PERFORMANCE CHARACTERISTICS

### Vout Voltage vs Load Current

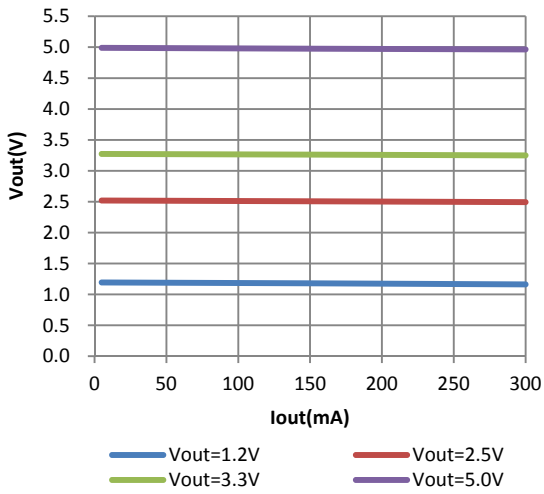

### Line Regulation

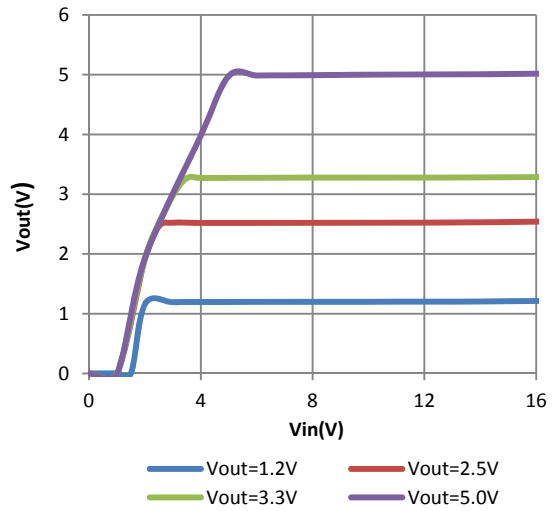

### Dropout Voltage vs Load Current

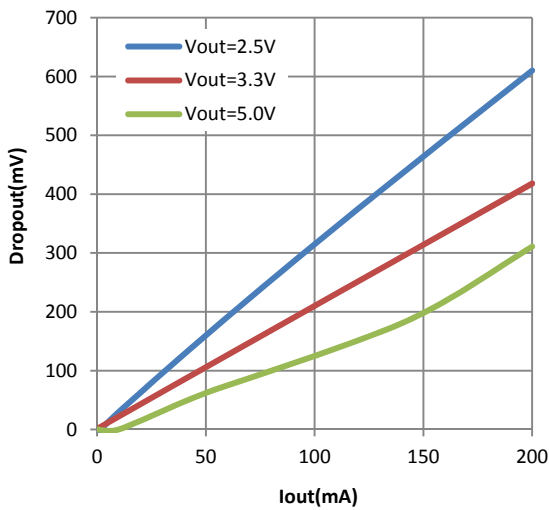

### Iq

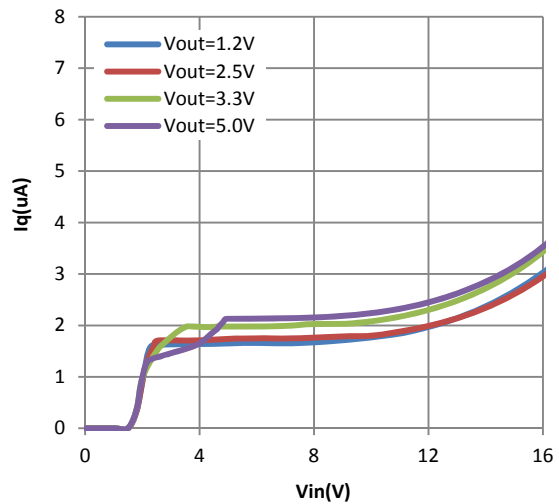

### Current Limit

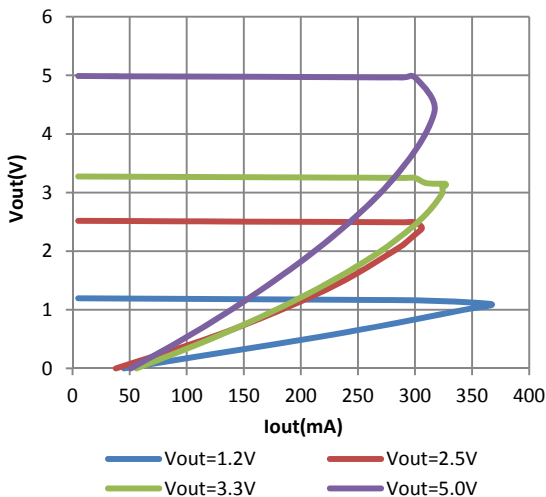

## Line transient response

Vin=6V~7V, Ch1—Vout, Ch3—Vin

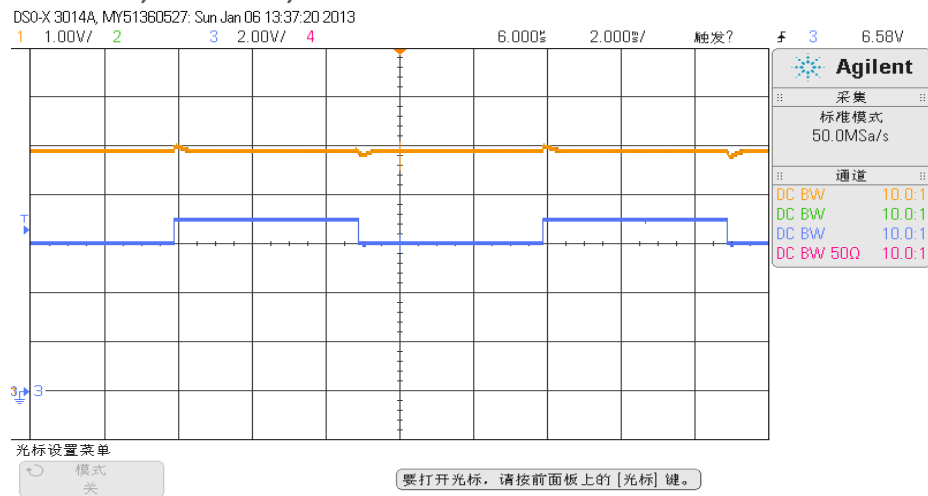

## Load transient response

Iout=1mA~100mA, Ch1—Vout, Ch4—Iout

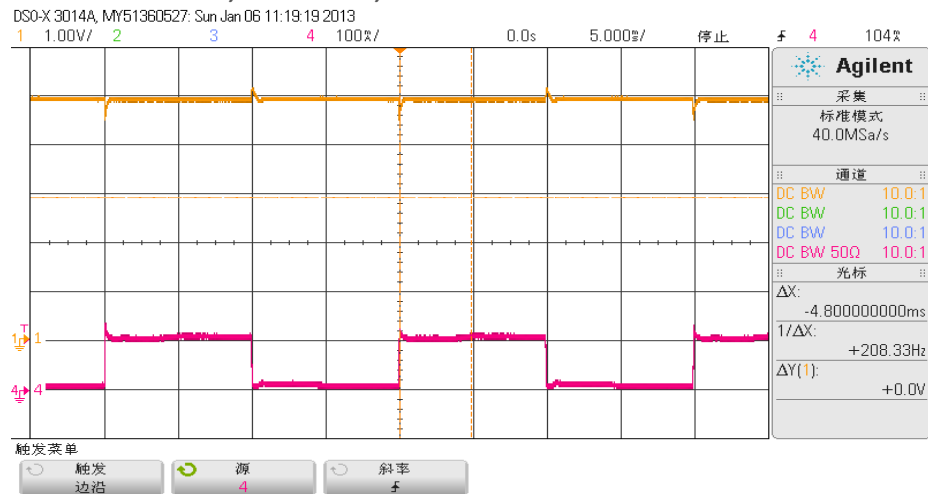

## Start up

Ch1—Vout, Ch3—Vin

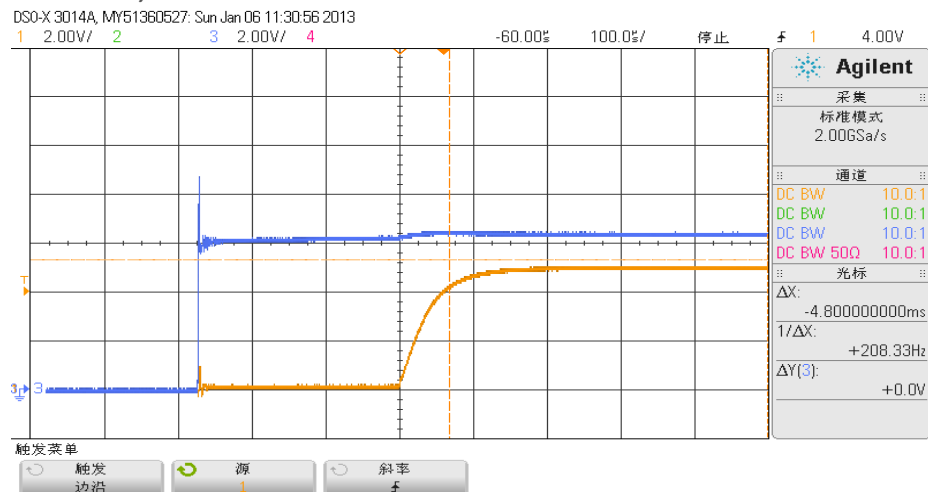

## PACKAGE LINE

Package	SOT-23-3	Devices per reel	3000Pcs	Unit	mm
Package dimension:					
<p>Technical drawing of the SOT-23-3 package. The top view shows a width of <math>2.9 \pm 0.2</math> mm and a lead spacing of <math>1.9 \pm 0.2</math> mm between leads 1 and 2. Lead 3 is centered, with a width of <math>0.4 \pm 0.1</math> mm. The body height is <math>1.6 \pm 0.2</math> mm, and the total height including leads is <math>2.8 \pm 0.3</math> mm. The side view shows a maximum lead height of <math>1.4</math> mm, a lead width of <math>1.1</math> mm (tolerance <math>+0.2/-0.1</math>), a lead thickness of <math>0.8</math> mm, and a lead angle of <math>0</math> to <math>0.1</math> degrees. The lead height at the base is <math>0.16</math> mm (tolerance <math>+0.1/-0.06</math>), and the minimum lead thickness is <math>0.2</math> mm. A perspective view shows the package with three leads labeled 1, 2, and 3.</p>					

Package	SOT-23-5	Devices per reel	3000Pcs	Unit	mm
Package Dimension:					
<p>Technical drawing of the SOT-23-5 package. The top view shows a width of <math>2.9 \pm 0.2</math> mm and a lead spacing of <math>1.9 \pm 0.2</math> mm between leads 1 and 2. Leads 3 and 4 are centered, with a width of <math>0.4 \pm 0.1</math> mm. The body height is <math>1.6</math> mm (tolerance <math>+0.2/-0.1</math>), and the total height including leads is <math>2.8 \pm 0.3</math> mm. The side view shows a maximum lead height of <math>1.1</math> mm (tolerance <math>+0.2/-0.1</math>), a lead width of <math>0.8 \pm 0.1</math> mm, and a lead angle of <math>0</math> to <math>0.1</math> degrees. The lead height at the base is <math>0.15</math> mm (tolerance <math>+0.1/-0.05</math>), and the minimum lead thickness is <math>0.2</math> mm. A perspective view shows the package with five leads labeled 1, 2, 3, 4, and 5.</p>					

Package	SOT-89-3	Devices per reel	1000Pcs	Unit	mm
<p>Package Dimension:</p> <p>The technical drawing illustrates the SOT-89-3 package dimensions in millimeters. It includes three views: a top view, a side view, and a bottom view. The top view shows a rectangular body with a central circular feature of diameter <math>\varnothing 1.0</math>. The overall width is <math>4.5 \pm 0.1</math> mm, and the width of the top flange is <math>1.6 \pm 0.2</math> mm. The height of the top flange is <math>0.4</math> mm. The distance from the top edge to the center of the circular feature is <math>2.5 \pm 0.1</math> mm. The total height of the package is <math>4.25</math> mm maximum. The distance from the bottom edge to the center of the circular feature is <math>0.8</math> mm minimum. The bottom view shows three leads labeled 1, 2, and 3. The distance between the centers of leads 1 and 2 is <math>1.5 \pm 0.1</math> mm, and the distance between the centers of leads 2 and 3 is <math>1.5 \pm 0.1</math> mm. The distance from the center of lead 2 to the left edge is <math>0.42 \pm 0.2</math> mm, and to the right edge is <math>0.42 \pm 0.2</math> mm. The width of each lead is <math>0.47 \pm 0.1</math> mm. The side view shows the profile of the package with a width of <math>1.5 \pm 0.1</math> mm at the top and <math>0.4 \pm 0.1</math> mm at the bottom. The distance from the top edge to the bottom edge is <math>0.4 \pm 0.1</math> mm.</p>					